

AM-U30

EQUALIZER PCB A2015A501B

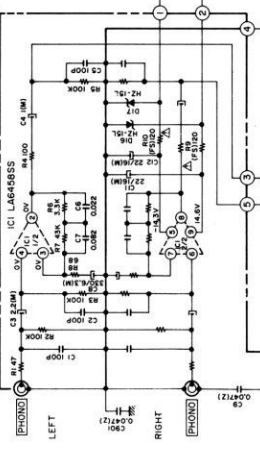

A

B

C

D

E

F

G

H

J

K

L

M

N

O

P

Q

R

S

T

U

V

W

X

Y

Z

AA

AB

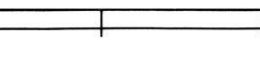
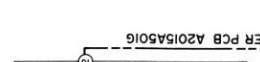
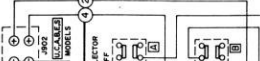
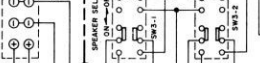
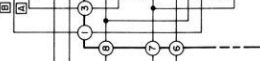
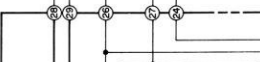
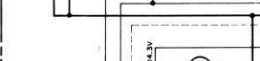
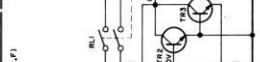
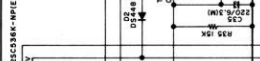
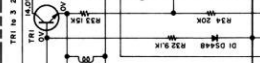
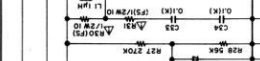
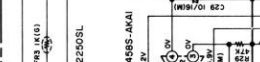
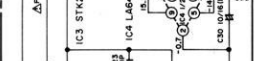
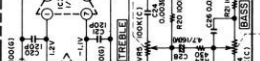
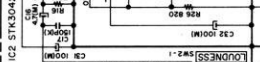
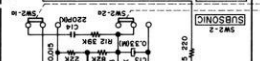
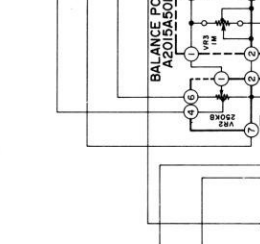

2

3

4

5

6

7

8

9

10

11

12

13

14

15

16

17

18

19

20

21

22

23

24

25

26

27

28

29

FUNCTION PCB A2015A501D

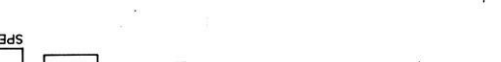
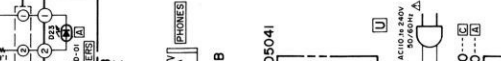
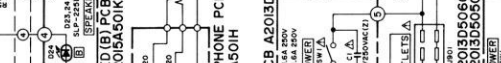
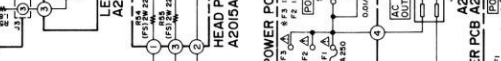
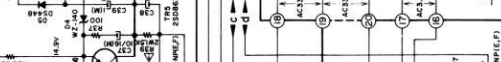
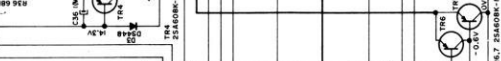
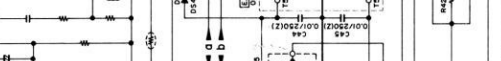
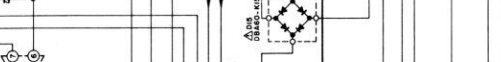
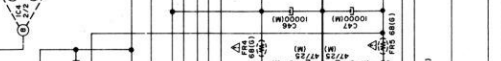
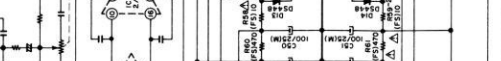
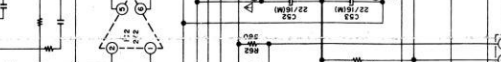
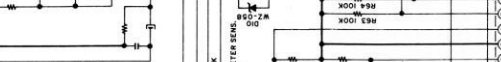
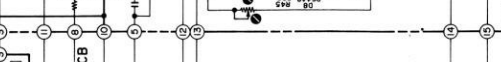
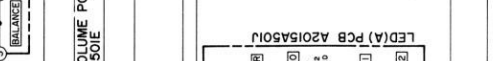
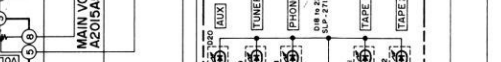
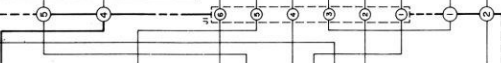
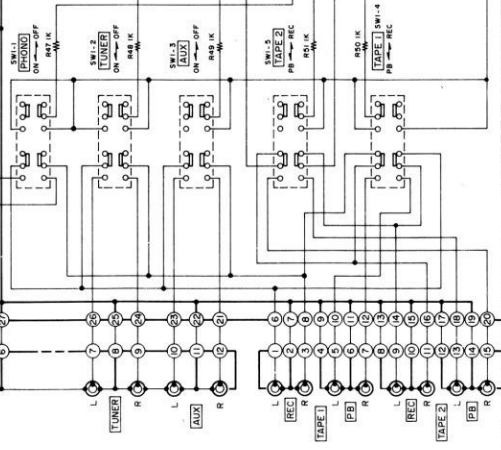

MAIN PCB A2015A501A

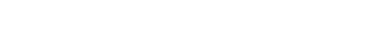
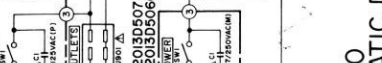
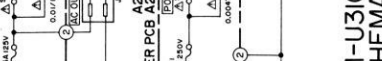
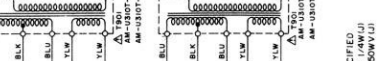
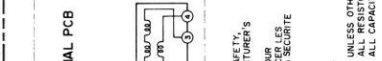
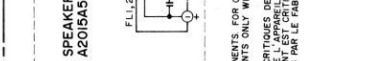
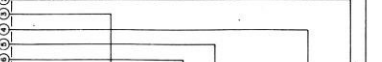
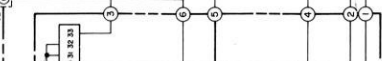
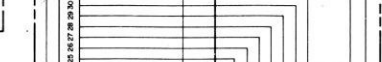
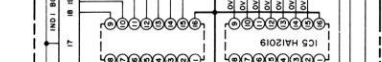
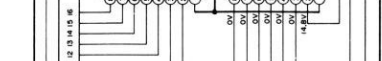
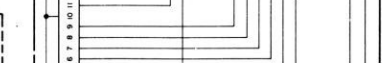
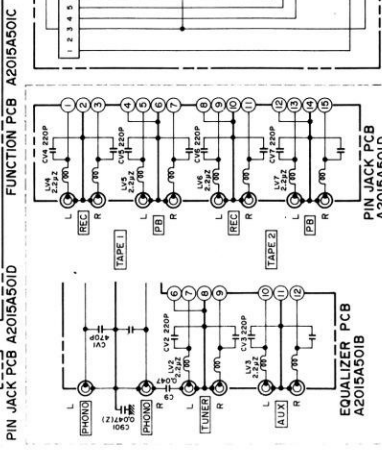

EQUALIZER PCB A2015A501B

PIN JACK PCB A2015A501D

EQUALIZER PCB A2015A501B

PIN JACK PCB A2015A501D

EQUALIZER PCB A2015A501B

PIN JACK PCB A2015A501D

EQUALIZER PCB A2015A501B

PIN JACK PCB A2015A501D

EQUALIZER PCB A2015A501B

PIN JACK PCB A2015A501D

EQUALIZER PCB A2015A501B

PIN JACK PCB A2015A501D

EQUALIZER PCB A2015A501B

PIN JACK PCB A2015A501D

EQUALIZER PCB A2015A501B

PIN JACK PCB A2015A501D

EQUALIZER PCB A2015A501B

PIN JACK PCB A2015A501D

EQUALIZER PCB A2015A501B

PIN JACK PCB A2015A501D

EQUALIZER PCB A2015A501B

PIN JACK PCB A2015A501D

EQUALIZER PCB A2015A501B

PIN JACK PCB A2015A501D

EQUALIZER PCB A2015A501B

PIN JACK PCB A2015A501D

EQUALIZER PCB A2015A501B

PIN JACK PCB A2015A501D

AM-U30 SCHEMATIC DIAGRAM NO. 1640406A

NOTE: UNLESS OTHERWISE SPECIFIED, ALL RESISTORS IN OHMS (AWW) ALL CAPACITORS IN PF (50WV) IC2 - STK 5042 IC3 - STK 2250

